

www.nunoendustri.com

SÜRTÜNME PLAKASI

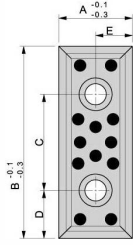

FORM A

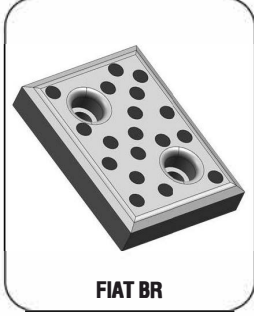
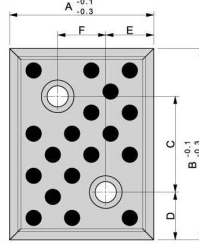

FORM B

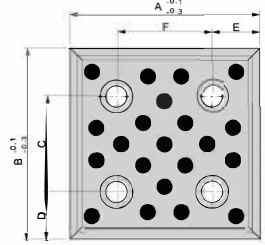

FORM C

SİPARİŞ ÖRNEĞİ

SPB01 75 150
A B

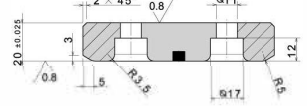

Not: Toleransız tüm ölçüler EN 22768-1(m) standardına göre tüm köşelere pah kırılacak.

Malzeme: SAE 430B HB>180 Kendinden yağlanmayı sağlayan özel grafit

SPB01

A ▶	38▼		75▼		100▼		38▼		75▼		100▼	
B ▶	100	150	100	150	50	100	100	150	100	150	100	150
C ▶	50	100	50	100	50	100	50	100	50	100	50	100
D ▶	25	25	25	25	25	25	25	25	25	25	25	25
E ▶	19	19	25	37.5	25	25	19	19	25	37.5	25	25
F ▶	-	-	25	-	50	50	-	-	25	-	50	50
Form ▶	A	A	B	A	C	C	A	A	B	A	C	C

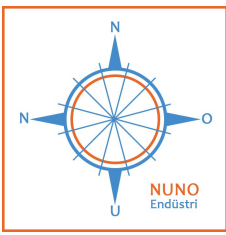

www.nunoendustri.com

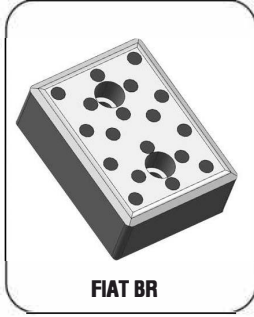

FIAT BR

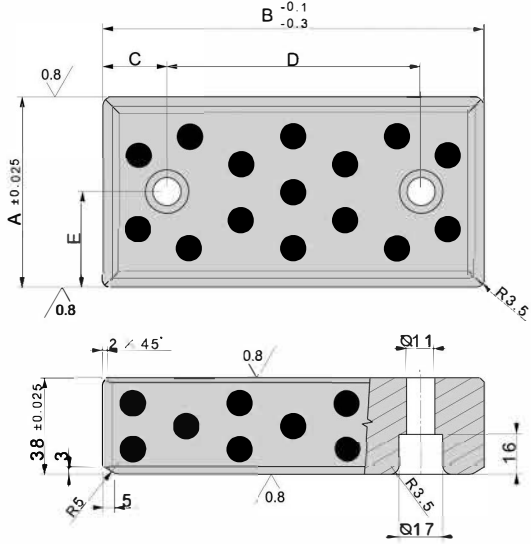

SIPARIŞ ÖRNEĞİ

SPB02 75 100
A B

Not: Toleranssız tüm ölçüler EN 22768-1(m) standardına göre tüm köşelere pah kırılacak.

Malzeme: SAE 430B HB>180 Kendinden yağlanmayı sağlayan özel grafit

SPB02

A ▶	75 ▼	75 ▼	75 ▼	75 ▼
B ▶	100	150	100	150
C ▶	25	25	25	25
D ▶	50	100	50	100
E ▶	37.5	37.5	37.5	37.5

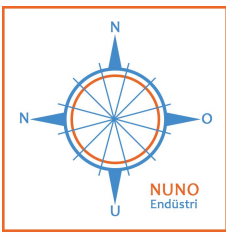

www.nunoendustri.com

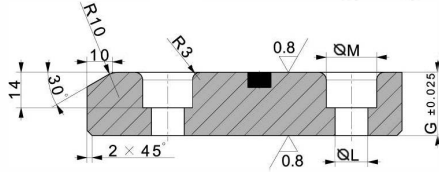
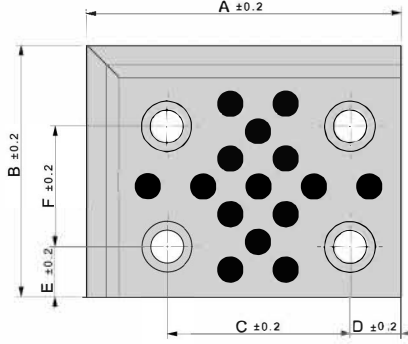
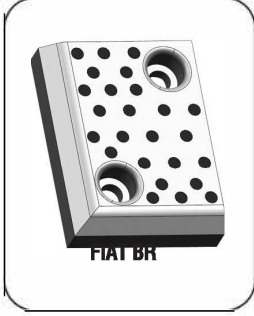

SIPARIŞ ÖRNEĞİ

SPB03 100 75
A B

Not: Toleranssız tüm ölçüler EN 22768-1(m) standardına göre tüm köşelere pah kırılacak.

Malzeme: SAE 430B HB>180 Kendinden yağlanmayı sağlayan özel grafit

SPB03

A ▶	100 ▼	125 ▼	150 ▼	100 ▼	125 ▼	150 ▼
B ▶	75	100	125	75	100	125
C ▶	60	73	93	60	73	93
D ▶	15	20	25	15	20	25
E ▶	15	20	25	15	20	25
F ▶	35	48	68	35	48	68
G ▶	18	25	25	18	25	25
H ▶	12	14	14	12	14	14
L ▶	11	13	13	11	13	13
M ▶	18	20	20	18	20	20
Delik Sayısı ▶	2	4	4	2	4	4

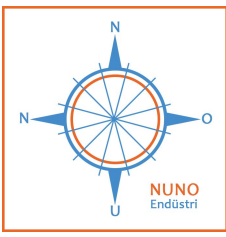

www.nunoendustri.com



SİPARİŞ ÖRNEĞİ
SPB04 200 20
A B

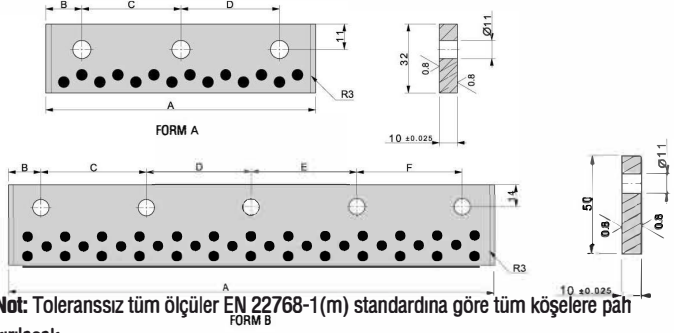

Not: Toleranssız tüm ölçüler EN 22768-1(m) standardına göre tüm köşelere pah kırılacak.

Malzeme: SAE 430B HB>180 Kendinden yağlanmayı sağlayan özel grafit

SPB04

A ▶	100 ▼	150 ▼	200 ▼	250 ▼	300 ▼
B ▶	20	20	20	20	20
C ▶	60	55	55	70	65
D ▶	-	55	50	70	65
E ▶	-	-	55	70	65
F ▶	-	-	-	-	65
Form ▶	A	A	B	B	B
Delik Sayısı ▶	2	3	4	4	5

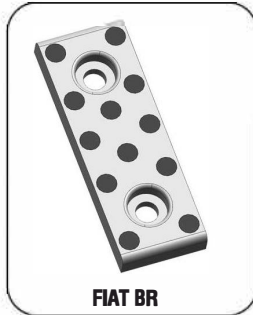

SİPARİŞ ÖRNEĞİ
SPB05 150
A

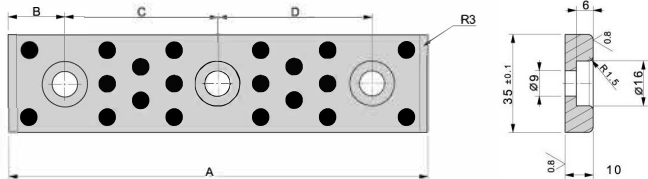

SPB05

A ▶	100 ▼	150 ▼
B ▶	20	20
C ▶	60	55
D ▶	-	55
Delik Sayısı ▶	2	3

Not: Toleranssız tüm ölçüler EN 22768-1(m) standardına göre tüm köşelere pah kırılacak.

Malzeme: SAE 430B HB>180 Kendinden yağlanmayı sağlayan özel grafit

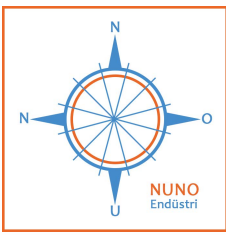

www.nunoendustri.com

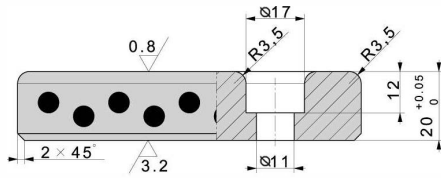
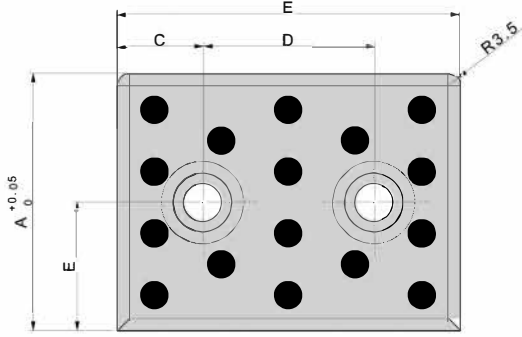

SIPARIŞ ÖRNEĞİ

SPB06 48 150
A B

Not: Toleranssız tüm ölçüler EN 22768-1(m) standardına göre tüm köşelere pah kırılacak.

Malzeme: SAE 430B HB>180 Kendinden yağlanmayı sağlayan özel grafit

SPB06

A ▶	48 ▼	48 ▼	75 ▼	75 ▼	48 ▼	48 ▼	75 ▼	75 ▼
B ▶	100	150	100	150	100	150	100	150
C ▶	25	25	25	25	25	25	25	25
D ▶	50	100	50	100	50	100	50	100
E ▶	24	24	24	24	24	24	24	24

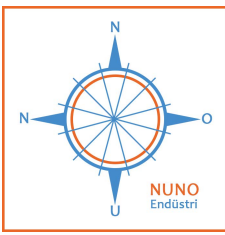

www.nunoendustri.com



VDI 3357

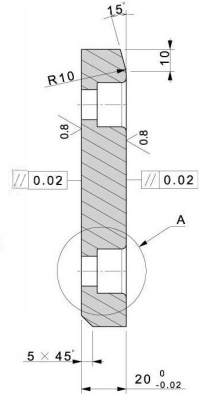
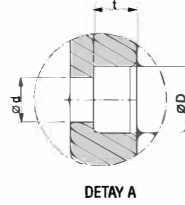
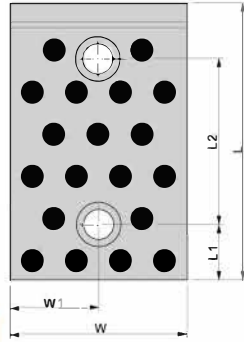

SİPARİŞ ÖRNEĞİ
SPB08 100 125
W L

Not: Toleransız tüm ölçüler EN 22768-1(m) standardına göre tüm köşelere pah kırılacak.

Malzeme: SAE 430B HB>180 Kendinden yağlanmayı sağlayan özel grafit

SPB08

W ▶	$+0$ -0.2	50	50	50	50	50	80	80	80	80	80	80	80	100	100	100	100	100	100
L ▶	$+0$ -0.2	80	100	125	160	200	80	100	125	160	200	250	315	100	125	160	200	250	315
W1 ▶	+0,1	25	25	25	25	25	40	40	40	40	40	40	40	50	50	50	50	50	50
L1 ▶	+0,1	25	25	25	25	25	25	25	25	25	25	40	40	25	25	25	25	40	40
L2 ▶	+0,1	30	50	75	110	150	30	50	75	110	150	170	235	50	75	110	150	170	235
D ▶	-	15	20	20	20	20	20	20	20	20	20	20	20	20	20	20	20	20	20
d ▶	-	9	13.5	13.5	13.5	13.5	13.5	13.5	13.5	13.5	13.5	13.5	13.5	13.5	13.5	13.5	13.5	13.5	13.5
t ▶	-	9	13	13	13	13	13	13	13	13	13	13	13	13	13	13	13	13	13

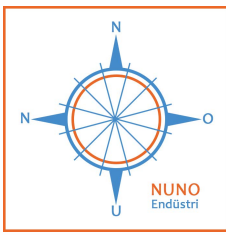

www.nunoendustri.com



VDI 3357

SIPARIŞ ÖRNEĞİ
SPB09 160 100
W L

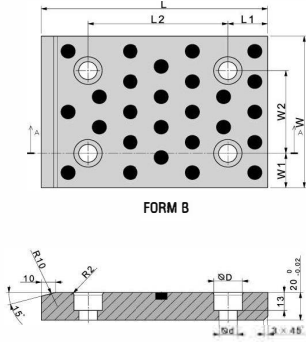

FORM B

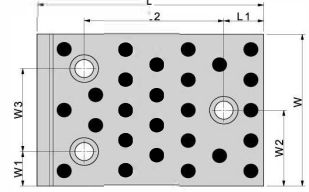

FORM C

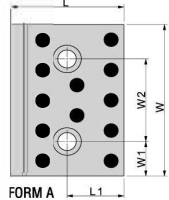

FORM A

Not: Toleransız tüm ölçüler EN 22768-1(m) standardına göre tüm köşelere pah kırılacak.

Malzeme: SAE 430B HB>180 Kendinden yağlanmayı sağlayan özel grafit

SPB09

W ▶	⁺⁰ / _{-0,2}	80	100	100	125	125	125	125	125	125	125	160	160	160	160	160	160	160			
L ▶	⁺⁰ / _{-0,2}	50	50	80	50	80	100	125	160	200	250	315	50	80	100	125	160	200	250	315	
W1 ▶	+0,1	25	25	25	25	25	25	25	25	25	25	25	25	25	25	25	25	25	25	25	25
W2 ▶	+0,1	30	50	50	75	75	62.5	62.5	62.5	62.5	62.5	110	110	80	80	80	80	80	110	110	
W3 ▶	+0,1	-	-	-	-	-	75	75	75	75	75	-	-	110	110	110	110	-	-	-	
L1 ▶	+0,1	25	25	40	25	40	25	25	25	25	40	40	25	40	25	25	25	25	40	40	
L2 ▶	+0,1	-	-	-	-	-	50	75	110	150	170	235	-	-	50	75	110	150	170	235	
D ▶	15	20	20	20	20	20	20	20	20	20	20	20	20	20	20	20	20	20	20	20	
d ▶	9	13.5	13.5	13.5	13.5	13.5	13.5	13.5	13.5	13.5	13.5	13.5	13.5	13.5	13.5	13.5	13.5	13.5	13.5	13.5	
t ▶	9	13	13	13	13	13	13	13	13	13	13	13	13	13	13	13	13	13	13	13	
Form ▶		A	A	A	A	A	C	C	C	C	C	C	A	A	C	C	C	C	C	B	B

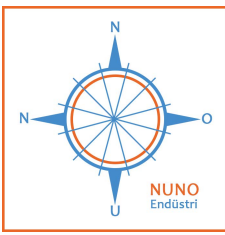

www.nunoendustri.com

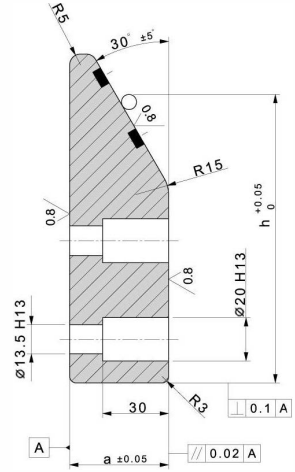
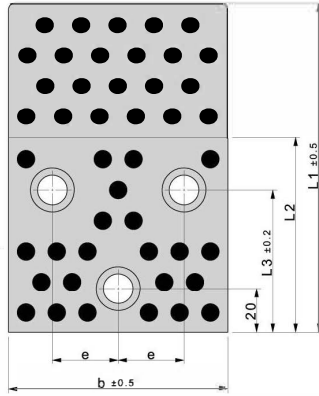
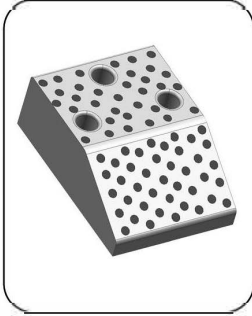

SİPARİŞ ÖRNEĞİ
SPB11 125 170
b L1

Not: Toleranssız tüm ölçüler EN 22768-1(m) standardına göre tüm köşelere pah kırılacak.
Malzeme: SAE 430B HB>180 Kendinden yağlanmayı sağlayan özel grafit

SPB11

b ▶	100	100	100	125	125	125	100	100	100	125	125	125	100	100	100	125	125	125
L1 ▶	130	150	170	130	150	170	130	150	170	130	150	170	130	150	170	130	150	170
e ▶	30	30	30	42.5	42.5	42.5	30	30	30	42.5	42.5	42.5	30	30	30	42.5	42.5	42.5
h ▶	132.9	127.9	127.9	132.9	127.9	127.9	132.9	127.9	127.9	132.9	127.9	127.9	132.9	127.9	127.9	132.9	127.9	127.9
L2 ▶	95	90	90	95	90	90	95	90	90	95	90	90	95	90	90	95	90	90
L3 ▶	70	65	65	70	65	65	70	65	65	70	65	65	70	65	65	70	65	65
a ▶	30	45	60	30	45	60	30	45	60	30	45	60	30	45	60	30	45	60

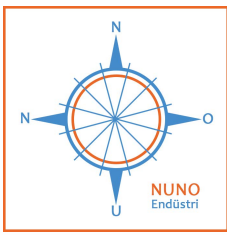

www.nunoendustri.com



VDI 3357

SİPARİŞ ÖRNEĞİ

SPB12 125 170 85
b a s

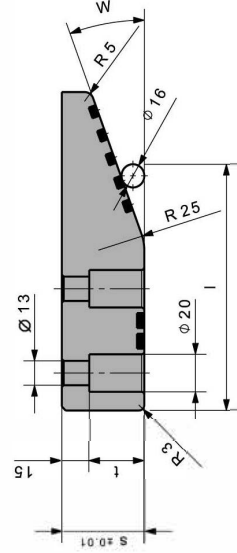
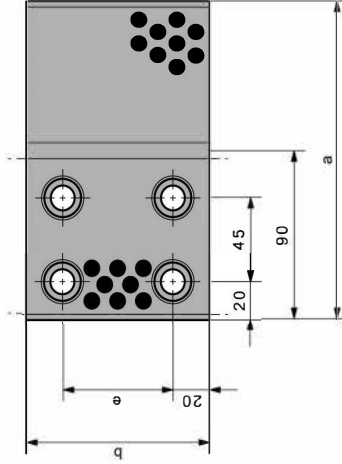

Not: Toleransız tüm ölçüler EN 22768-1(m) standardına göre tüm köşelere pah kırılacak.

Malzeme: SAE 430B HB>180 Kendinden yağlanmayı sağlayan özel grafit

SPB12

b ▶	100	125	150	100		125		150	
a ▶	170	170	170	150	170	150	170	150	170
s ▶	45	45	45	45	60	45	60	45	60
e ▶	60	85	110	60	60	85	85	110	110
t ▶	30	30	30	30	45	30	45	30	45
w ▶	20°	20°	20°	30°	30°	30°	30°	30°	30°
l ▶	143,37	143,37	143,37	127,86	127,86	127,86	127,86	127,86	127,86

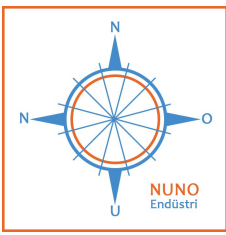

www.nunoendustri.com



Eski kod: SPB61

SİPARİŞ ÖRNEĞİ
SPB13 250
L

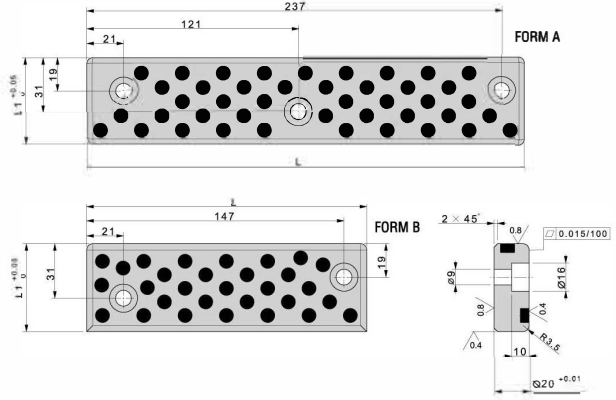

Not: Toleransız tüm ölçüler EN 22768-1(m) standardına göre tüm köşelere pah kırılacak.
Malzeme: SAE 430B HB>180 Kendinden yağlanmayı sağlayan özel grafit

SPB13

L ▶	160▼	250▼
E ▶	20	20
L1 ▶	50	50
Form ▶	B	A

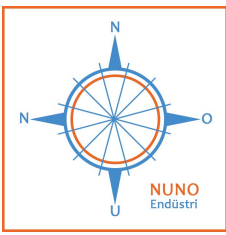

www.nunoendustri.com

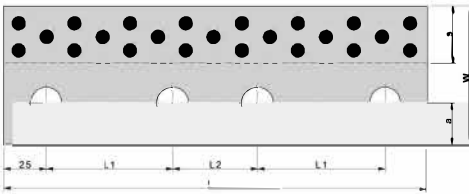
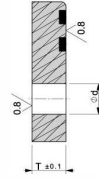
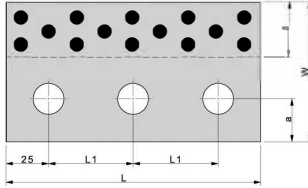
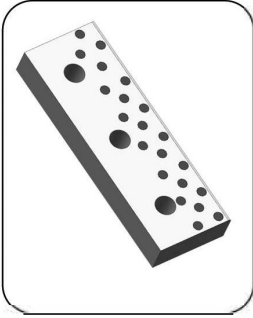

SIPARIŞ ÖRNEĞİ
SPB15 35 200
T L

Not: Toleranssız tüm ölçüler EN 22768-1(m) standardına göre tüm köşelere pah kırılacak.

Malzeme: SAE 430B HB>180 Kendinden yağlanmayı sağlayan özel grafit

SPB15

T ▶	20 ▼			30 ▼			35 ▼			40 ▼					
L ▶	150	200	250	150	200	250	150	200	250	150	200	250	150	200	250
W ▶	52	52	52	72	72	72	77	77	77	82	82	82	105	105	105
L1 ▶	50	75	75	50	75	75	50	75	75	50	75	75	50	50	75
L2 ▶	-	-	50	-	-	50	-	-	50	-	-	50	-	50	50
a ▶	20	20	20	25	25	25	25	25	25	25	25	25	25	25	25
s ▶	12	12	12	22	22	22	27	27	27	32	32	32	32	32	32
d ▶	13	13	13	18	18	18	18	18	18	18	18	18	18	18	18

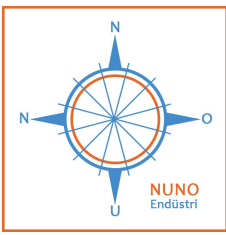

www.nunoendustri.com

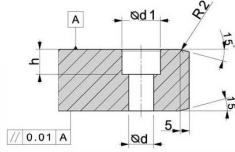
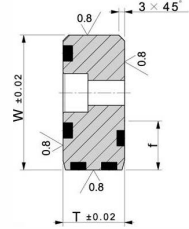
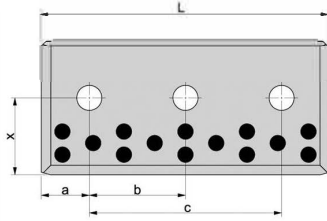

SIPARIŞ ÖRNEĞİ
SPB16 90 125
W L

Not: Toleranssız tüm ölçüler EN 22768-1(m) standardına göre tüm köşelere pah kırılacak.
Malzeme: SAE 430B HB>180 Kendinden yağlanmayı sağlayan özel grafit

SPB16

W ▶	70 ▼			90 ▼		
L ▶	125	150	200	125	150	200
h ▶	32	32	32	45	45	45
f ▶	25	25	25	30	30	30
a ▶	30	30	30	30	30	30
b ▶	75	100	75	75	50	75
c ▶	-	-	150	-	100	150
x ▶	40	40	40	55	55	55
Holes ▶	2	3	3	2	3	3
M ▶	M12	M12	M12	M16	M16	M16

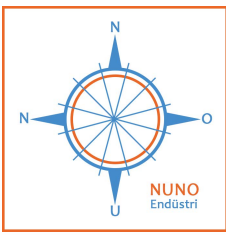

www.nunoendustri.com

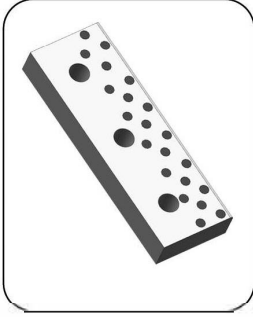

SIPARIŞ ÖRNEĞİ
SPB17 40 200
T L

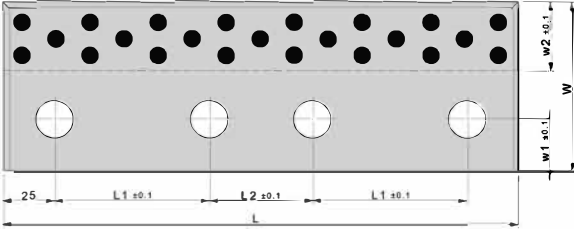
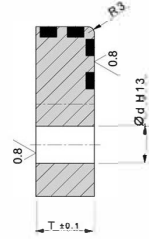
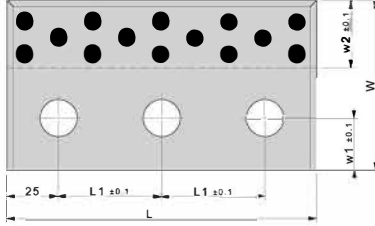

Not: Toleranssız tüm ölçüler EN 22768-1(m) standardına göre tüm köşelere pah kırılacak.

Malzeme: SAE 430B HB>180 Kendinden yağlanmayı sağlayan özel grafit

SPB17

T ▶	70▼			90▼			90▼			90▼		
L ▶	150	200	250	150	200	250	150	200	250	150	200	250
W ▶	52	52	52	72	72	72	77	77	77	82	82	82
L1 ▶	50	75	75	50	75	75	50	75	75	50	75	75
L2 ▶	-	-	50	-	-	50	-	-	50	-	-	50
w1 ▶	20	20	25	25	25	25	25	25	25	25	25	25
w2 ▶	12	12	12	22	22	22	27	27	27	32	32	32
d ▶	13	13	13	18	18	18	18	18	18	18	18	18
Holes ▶	3	3	4	3	3	4	3	3	4	3	3	4

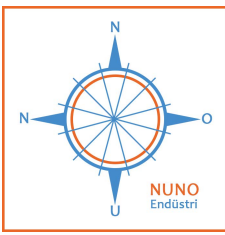

www.nunoendustri.com



VDI 3357

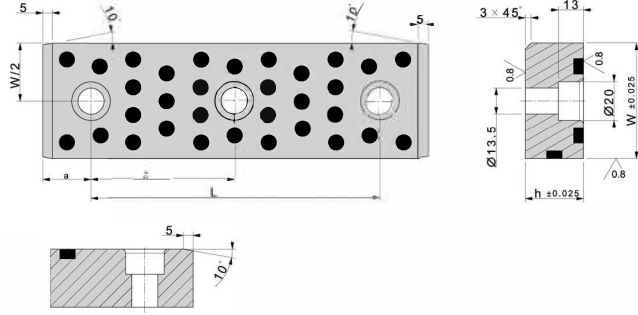

SİPARİŞ ÖRNEĞİ

SPB18 60 200 30
W L h

Not: Toleranssız tüm ölçüler EN 22768-1(m) standardına göre tüm köşelere pah kırılacak.

Malzeme: SAE 430B HB>180 Kendinden yağlanmayı sağlayan özel grafit

SPB18

W ▶	60 ▼	60 ▼	60 ▼	60 ▼	60 ▼	60 ▼
L ▶	125	150	200	125	150	200
h ▶	30	30	30	40	40	40
Delik Sayısı ▶	2	2	3	2	2	3
a ▶	25	25	25	25	25	25
b ▶	75	100	75	75	100	75
c ▶	-	-	150	-	-	150

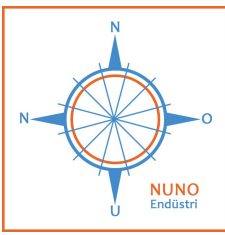

www.nunoendustri.com

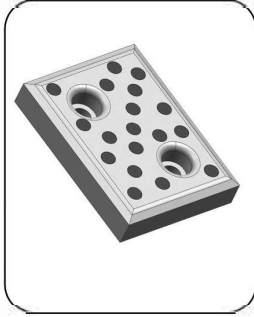

SIPARIŞ ÖRNEĞİ
SPB19 80 200
B L

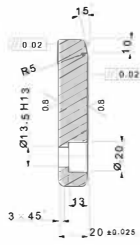
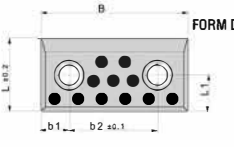
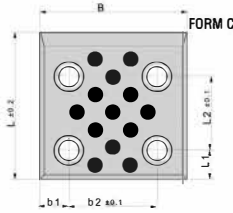
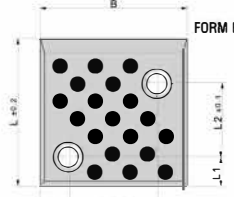
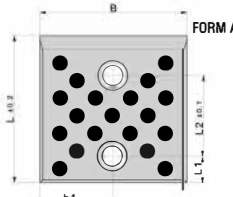

Not: Toleranssız tüm ölçüler EN 22768-1(m) standardına göre tüm köşelere pah kırılacak.
Malzeme: SAE 430B HB>180 Kendinden yağlanmayı sağlayan özel grafit

SPB19

B ▶	50 ▼					80 ▼					100 ▼				
L ▶	80	100	125	160	200	100	125	160	200	50	80	100	125	160	200
L1 ▶	20	20	20	20	20	20	20	20	20	25	20	20	20	20	20
L2 ▶	35	55	80	115	155	55	80	115	155	-	35	55	80	115	155
b1 ▶	25	25	25	25	25	20	20	20	20	20	20	20	20	20	20
b2 ▶	-	-	-	-	-	40	40	40	40	60	60	60	60	60	60
Form ▶	A	A	A	A	A	B	B	C	C	D	B	B	C	C	C

B ▶	125 ▼					160 ▼									
L ▶	80	100	125	160	200	100	125	160							
L1 ▶	20	20	20	20	20	20	20	20							
L2 ▶	35	55	80	115	155	55	80	115							
b1 ▶	20	20	20	20	20	20	20	20							
b2 ▶	85	85	85	85	85	120	120	120							
Form ▶	B	C	C	C	C	C	C	C							

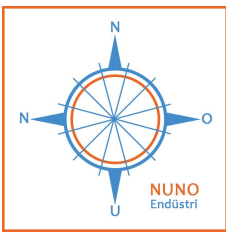

www.nunoendustri.com

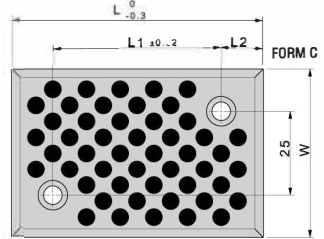
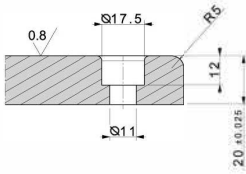
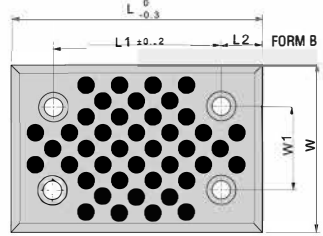
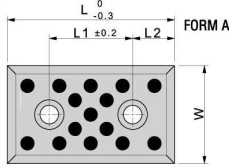

SIPARIŞ ÖRNEĞİ
SPB20 48 150
W L

Not: Toleranssız tüm ölçüler EN 22768-1(m) standardına göre tüm köşelere pah kırılacak.

Malzeme: SAE 430B HB>180 Kendinden yağlanmayı sağlayan özel grafit

SPB20

W ▶	28▼			38▼			48▼					58▼			75▼				
L ▶	75	100	150	75	100	150	75	100	125	150	200	75	100	150	75	100	125	150	200
W1 ▶	-	-	-	-	-	-	-	-	-	-	-	-	-	-	-	-	-	-	-
L1 ▶	45	50	100	45	50	100	45	50	75	100	150	45	50	100	25	50	75	100	150
L2 ▶	15	25	25	15	25	25	15	25	25	25	25	15	25	25	25	25	25	25	25
Form ▶	A	A	A	A	A	A	A	A	A	A	A	A	A	A	A/C	A/C	A	A	A

W ▶	100▼						125▼						150▼					
L ▶	100	125	150	200	250	300	125	150	200	250	300	350	150	200	250			
W1 ▶	50	50	50	50	50	50	50	50	50	50	50	50	100	100	100			
L1 ▶	50	75	100	150	200	200	75	100	150	200	200	200	100	150	200			
L2 ▶	25	25	25	25	25	50	25	25	25	25	50	75	25	25	25			
Form ▶	B	B	B	B	B	B	B	B	B	B	B	B	B	B	B			

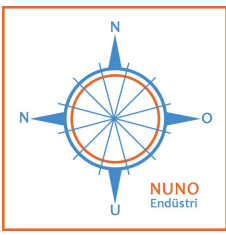

www.nunoendustri.com

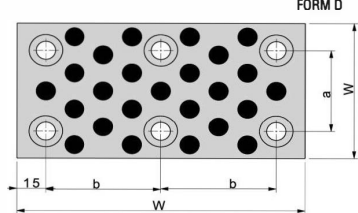
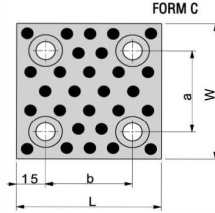
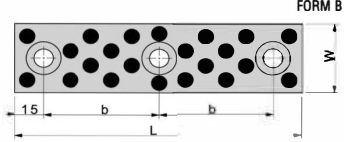
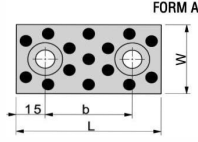

SİPARİŞ ÖRNEĞİ
SPB21 100 125
W L

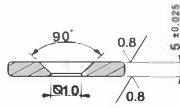

Not: Toleranssız tüm ölçüler EN 22768-1(m) standardına göre tüm köşelere pah kırılacak.
Malzeme: SAE 430B HB>180 Kendinden yağlanmayı sağlayan özel grafit

SPB21

W ▶	18 ▼				28 ▼				38 ▼				48 ▼				75 ▼				100 ▼						
L ▶	50	75	100	150	50	75	100	150	50	75	100	150	75	100	125	150	75	100	125	150	100	125	150	100	125	150	
A ▶	-	-	-	-	-	-	-	-	-	-	-	-	-	-	-	-	45	45	45	45	70	70	70	70	70	70	
B ▶	20	45	70	60	20	45	70	60	20	45	70	60	45	70	95	60	45	70	95	60	45	70	95	60	70	95	60
Form ▶	A	A	A	B	A	A	A	B	A	A	A	B	A	A	A	B	C	C	C	C	D	C	C	C	C	D	

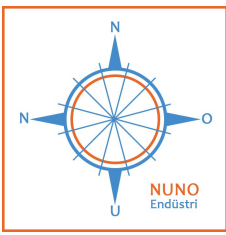

www.nunoendustri.com



SİPARİŞ ÖRNEĞİ
SPB22 35 300
W L

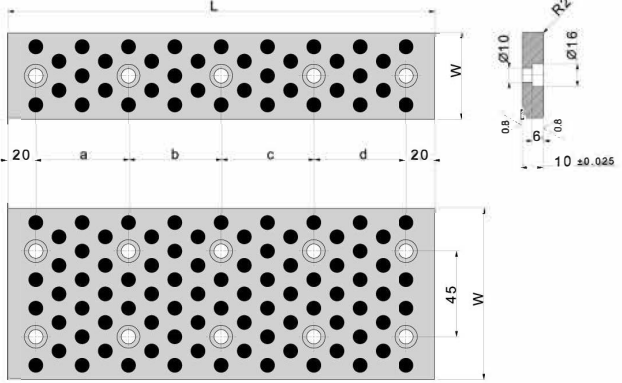

Not: Toleransız tüm ölçüler EN 22768-1(m) standardına göre tüm köşelere pah kırılacak.
Malzeme: SAE 430B HB>180 Kendinden yağlanmayı sağlayan özel grafit

SPB22

B ▶	35▼						50▼						75▼					
L ▶	100	150	200	250	300	350	100	150	200	250	300	350	150	200	250	300	400	500
A ▶	60	55	55	70	65	80	60	55	55	70	65	80	110	80	105	85	120	115
B ▶	-	55	50	70	65	75	-	55	50	70	65	75	-	80	105	90	120	115
C ▶	-	-	55	70	65	75	-	-	55	70	65	75	-	-	-	85	120	115
D ▶	-	-	-	-	65	80	-	-	-	-	65	80	-	-	-	-	-	115
Delik Sayısı ▶	2	3	4	4	5	5	2	3	4	4	5	5	4	6	6	8	8	10
Form ▶	A	A	A	A	A	A	A	A	A	A	A	A	B	B	B	B	B	B

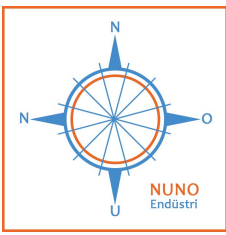

www.nunoendustri.com

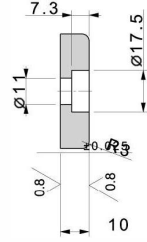
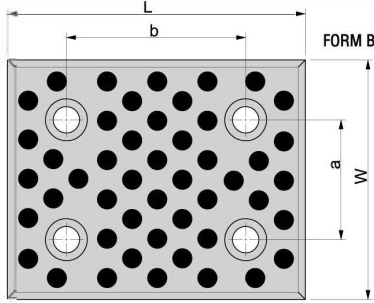
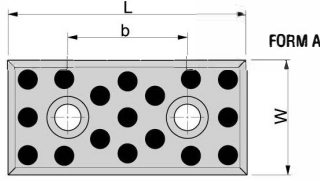

SIPARIŞ ÖRNEĞİ

SPB23 48 150
W L

Not: Toleranssız tüm ölçüler EN 22768-1(m) standardına göre tüm köşelere pah kırılacak.

Malzeme: SAE 430B HB>180 Kendinden yağlanmayı sağlayan özel grafit

SPB23

W ▶	28 ▼					38 ▼					48 ▼					75 ▼					100 ▼					125 ▼					150 ▼				
L ▶	75	100	125	150	75	100	125	150	75	100	125	150	200	75	100	125	150	200	100	125	150	200	250	150	200	250	150	200	100	100	100				
a ▶	-	-	-	-	-	-	-	-	-	-	-	-	-	-	-	-	-	-	50	50	50	50	50	50	50	50	50	50	100	100	100				
b ▶	45	50	75	100	45	50	75	100	45	50	75	100	150	25	50	75	100	150	50	75	100	150	50	75	100	150	200	100	100	100					
Form ▶	A	A	A	A	A	A	A	A	A	A	A	A	A	A	A	A	A	A	B	B	B	B	B	B	B	B	B	B	B	B	B				

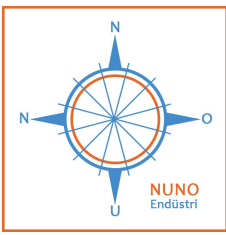

www.nunoendustri.com

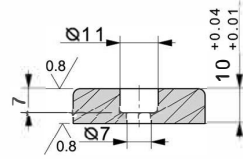
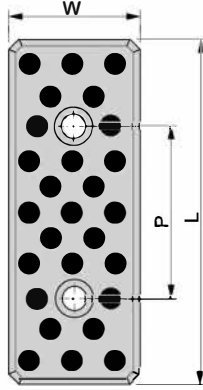

SİPARİŞ ÖRNEĞİ

SPB24 48 100
W L

Not: Toleranssız tüm ölçüler EN 22768-1(m) standardına göre tüm köşelere pah kırılacak.

Malzeme: SAE 430B HB>180 Kendinden yağlanmayı sağlayan özel grafit

SPB24

W ▶	18 ▼				28 ▼				38 ▼				48 ▼			
L ▶	75	100	125	150	75	100	125	150	75	100	125	150	75	100	125	150
P ▶	45	50	75	100	45	50	75	100	45	50	75	100	45	50	75	100

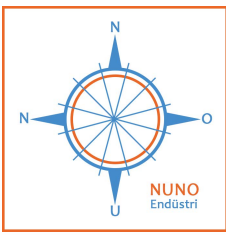

www.nunoendustri.com

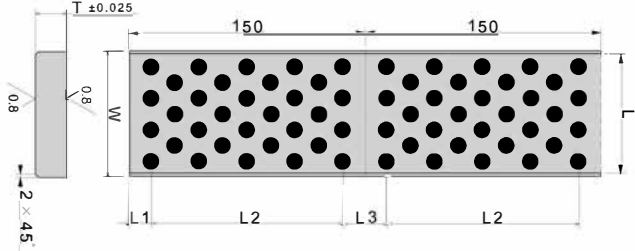
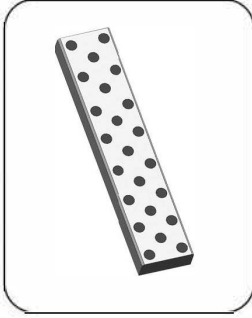

SIPARIŞ ÖRNEĞİ

SPB25 50 600 10
W L T

Not: Toleranssız tüm ölçüler EN 22768-1(m) standardına göre tüm köşelere pah kırılacak.

Malzeme: SAE 430B HB>180 Kendinden yağlanmayı sağlayan özel grafit

SPB25

W ▶	50 ▼			80 ▼			100 ▼			150 ▼			50 ▼			80 ▼			100 ▼			150 ▼		
L ▶	300	600	1050	300	600	1050	300	600	1050	300	600	1050	300	600	1050	300	600	1050	300	600	1050	300	600	1050
T ▶	10	10	10	10	10	10	10	10	10	10	10	10	20	20	20	20	20	20	20	20	20	20	20	20
L1 ▶	11	11	11	11	11	11	11	11	11	11	11	11	14	14	14	14	14	14	14	14	14	14	14	14
L2 ▶	128	128	128	128	128	128	128	128	128	128	128	128	122	122	122	122	122	122	122	122	122	122	122	122
L3 ▶	22	22	22	22	22	22	22	22	22	22	22	22	28	28	28	28	28	28	28	28	28	28	28	28
Çv. ▶	M6	M6	M6	M6	M6	M6	M6	M6	M6	M6	M6	M6	M10	M10	M10	M10	M10	M10	M10	M10	M10	M10	M10	M10

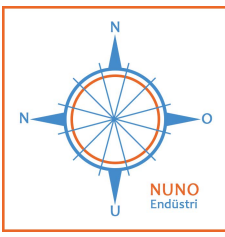

www.nunoendustri.com

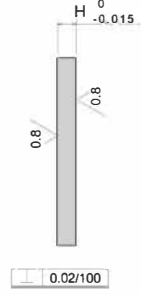
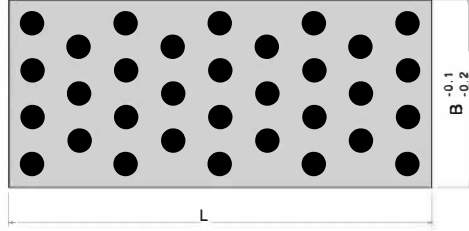
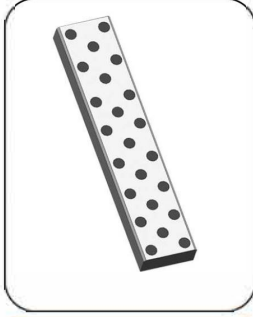

SIPARIŞ ÖRNEĞİ

SPB26 6 125 25
H L B

Not: Toleranssız tüm ölçüler EN 22768-1(m) standardına göre tüm köşelere pah kırılacak.
Malzeme: SAE 430B HB>180 Kendinden yağlanmayı sağlayan özel grafit

SPB26

H ▶	6▼					8▼					6▼	8▼	10▼						
L ▶	50	63	80	100	125	80	100	125	160	200	125	160	200	250	315	500	500	500	500
B ▶	25	25	25	25	25	40	40	40	40	40	63	63	63	63	63	25	40	63	80

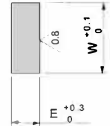
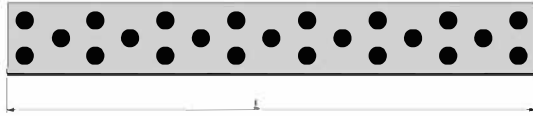
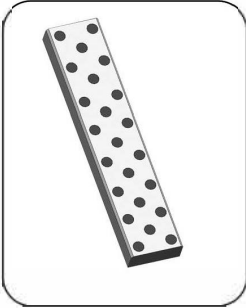

SIPARIŞ ÖRNEĞİ

SPB27 40 605 12
W L E

Not: Toleranssız tüm ölçüler EN 22768-1(m) standardına göre tüm köşelere pah kırılacak.
Malzeme: SAE 430B HB>180 Kendinden yağlanmayı sağlayan özel grafit

SPB27

H ▶	20▼	25▼	30▼	30▼	35▼	40▼	40▼	50▼	60▼	60▼	80▼	80▼	80▼	100▼	100▼
L ▶	305	305	305	400	605	605	605	605	605	1005	605	605	1005	605	1005
E ▶	4	5	6	6	10	8	12	10	16	16	12	20	20	20	20

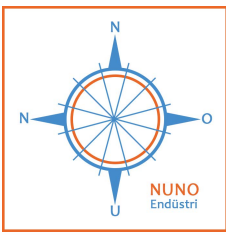

www.nunoendustri.com



AFNOR / ISO9183-2

SIPARIŞ ÖRNEĞİ

SPB30 70 200 Form
b a A

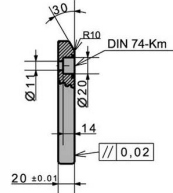
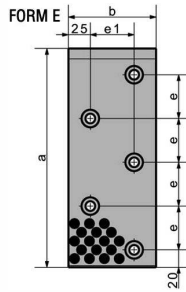
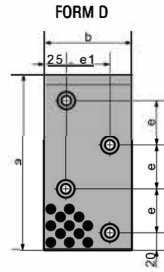
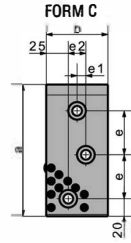
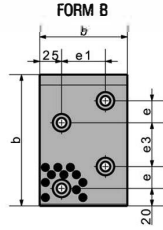
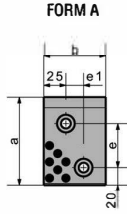

Not: Toleransız tüm ölçüler EN 22768-1(m) standardına göre tüm köşelere pah kırılacak.

Malzeme: SAE 430B HB>180 Kendinden yağlanmayı sağlayan özel grafit

SPB30

b ▶	70▼	70▼	70▼	100▼	100▼	100▼	150▼	150▼
a ▶	100	150	200	150	200	250	200	250
Form ▶	A	B	D	C	D	E	D	E
e1 ▶	20	10	20	50	50	50	100	100
e4 ▶								
e ▶	50		25	50				
e3 ▶	-	-	-	50	-	-	-	-
e2 ▶	-	20	-	-	-	-	-	-
Delik Sayısı ▶	2	3	4	4	4	5	4	5

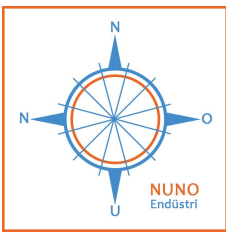

www.nunoendustri.com

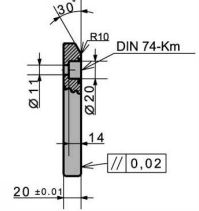
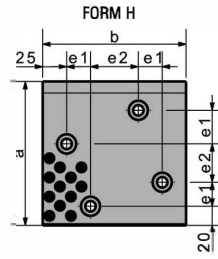
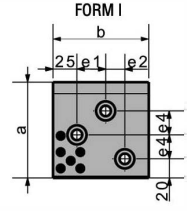
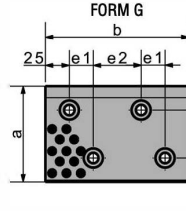
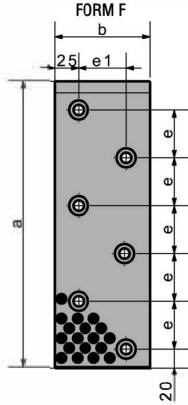

SIPARIŞ ÖRNEĞİ
 SPB30 100 300 F
 b a Form

Not: Toleranssız tüm ölçüler EN 22768-1(m) standardına göre tüm köşelere pah kırılacak.
Malzeme: SAE 430B HB>180 Kendinden yağlanmayı sağlayan özel grafit

SPB30

b ▶	100▼	100▼	150▼	150▼	150▼	200▼
a ▶	100	300	100	150	300	100
Form ▶	I	F	G	H	F	G
e1 ▶	30	50	25	25	100	50
e4 ▶	25	-	-	-	-	-
e ▶	-	50	-	-	50	-
e3 ▶	-	-	50	-	-	50
e2 ▶	20	-	50	50	-	50
Delik Sayısı ▶	3	6	4	4	6	4

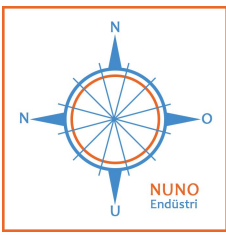

www.nunoendustri.com



AFNOR / ISO9183-2

SİPARİŞ ÖRNEĞİ

SPB31 70 100 A
b a Form

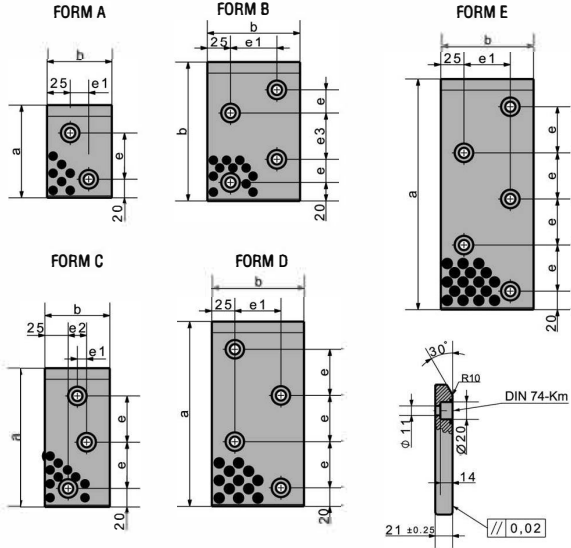

Not: Toleranssız tüm ölçüler EN 22768-1(m) standardına göre tüm köşelere pah kırılacak.

Malzeme: SAE 430B HB>180 Kendinden yağlanmayı sağlayan özel grafit

SPB31

b ▶	70▼	70▼	70▼	100▼	100▼	100▼	150▼	150▼
a ▶	100	150	200	150	200	250	200	250
Form ▶	A	B	D	C	D	E	D	E
e1 ▶	20	10	20	50	50	50	100	100
e4 ▶								
e ▶	50		25	50				
e3 ▶	-	-	-	50	-	-	-	-
e2 ▶	-	20	-	-	-	-	-	-
Delik Sayısı▶	2	3	4	4	4	5	4	5

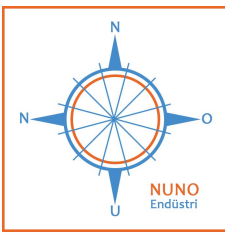

www.nunoendustri.com



SIPARIŞ ÖRNEĞİ
 SPB31 100 300 F
 b a Form

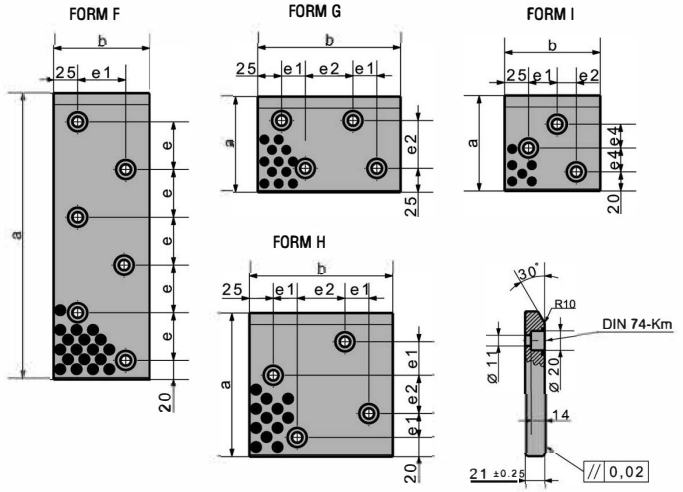

Not: Toleranssız tüm ölçüler EN 22768-1(m) standardına göre tüm köşelere pah kırılacak.

Malzeme: SAE 430B HB>180 Kendinden yağlanmayı sağlayan özel grafit

SPB31

b ▶	100 ▼	100 ▼	150 ▼	150 ▼	150 ▼	200 ▼
a ▶	100	300	100	150	300	100
Form ▶	I	F	G	H	F	G
e1 ▶	30	50	25	25	100	50
e4 ▶	25	-	-	-	-	-
e ▶	-	50	-	-	50	-
e3 ▶	-	-	50	-	-	50
e2 ▶	20	-	50	50	-	50
Delik Sayısı ▶	3	6	4	4	6	4

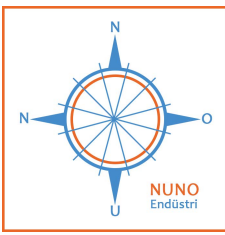

www.nunoendustri.com

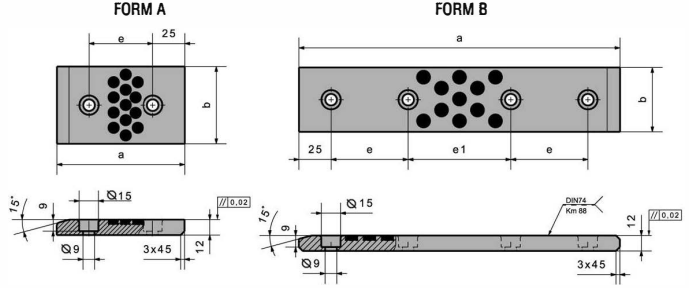

SIPARIŞ ÖRNEĞİ
SPB32 80 125 A
b s Form

Not: Toleransız tüm ölçüler EN 22768-1(m) standardına göre tüm köşelere pah kırılacak.

Malzeme: SAE 430B HB>180 Kendinden yağlanmayı sağlayan özel grafit

SPB32

b	a	Form	e	e1	Delik Sayısı
30	80	A	30		2
	100		50		2
	125		75		2
	160		110		2
	200		150		2
40	80		30		2
	100		50		2
	125		75		2
	160		110		2
	200		150		2
50	80		30		2
	100		50		2
	125		75		2
	160		110		2
	200		150		2
50	250	B	60	80	4
	300		80	90	4
	350		100	100	4
	400		120	110	4
60	80	A	30		2
	100		50		2
	125		75		2
	160		110		2
	200		150		2
80	80		30		2
	100		50		2
	125		75		2
	160		110		2
	200		150		2

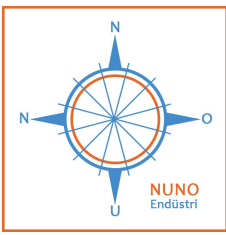

www.nunoendustri.com

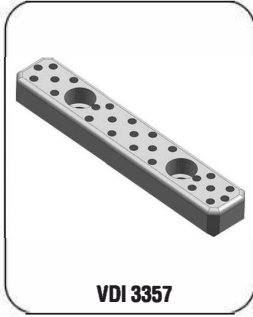

VDI 3357

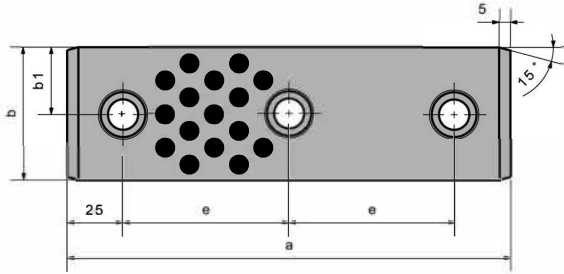
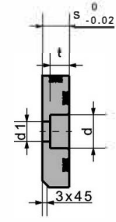
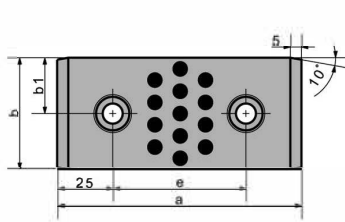

SİPARİŞ ÖRNEĞİ

SPB33 60 30 200
b s a

Not: Toleranssız tüm ölçüler EN 22768-1(m) standardına göre tüm köşelere pah kırılacak.
Malzeme: SAE 430B HB>180 Kendinden yağlanmayı sağlayan özel grafit

SPB33

a ▶	110	120	110	120	125	150	160	200	125	150	160	200
b ▶	25	25	60						60			
Form ▶	A		A		A			B	A			B
s ▶	12		15		30				30			
b1 ▶	12,5		12,5		30				30			
e ▶	60	70	60	70	75	100	110	75	75	100	110	75
d ▶	15		18		20				20			
d1 ▶	9		11		13,5				13,5			
t ▶	8,5		10,5		13				13			
Delik Sayısı ▶	2		2		2				2			

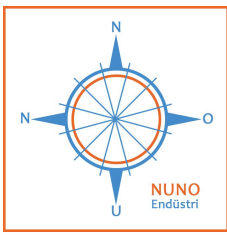

www.nunoendustri.com

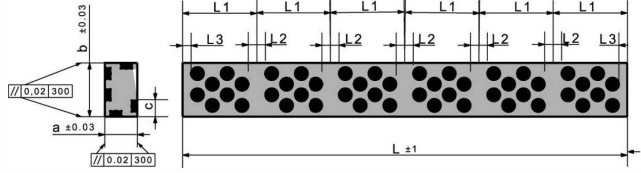
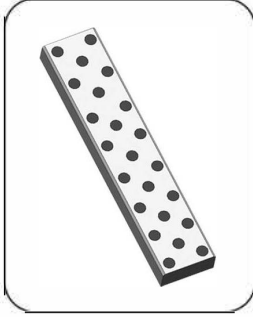

SIPARIŞ ÖRNEĞİ

SPB34 25 15 125
b a L

Not: Toleranssız tüm ölçüler EN 22768-1(m) standardına göre tüm köşelere pah kınılacak.

Malzeme: SAE 430B HB>180 Kendinden yağlanmayı sağlayan özel grafit

SPB34

a	b	c	l	l1	l2	l3
10,3	15,3	6	75	25	6	3
			100			
			125			
			150			
			175			
			200			
			225			
			250			
			275			
			300			
15,3	25,3	8	105	35	8	4
			140			
			175			
			210			
			245			
			280			
			315			
			350			
			385			
			420			
25,3	35,3	12	135	45	10	5
			180			
			225			
			270			
			315			
			360			
			405			
			450			
			495			
35,3	45,3	16	165	55	12	6
			220			
			275			
			330			
			385			
			440			
			495			

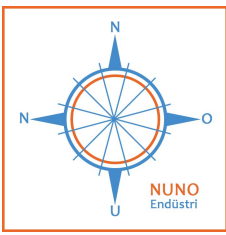

www.nunoendustri.com

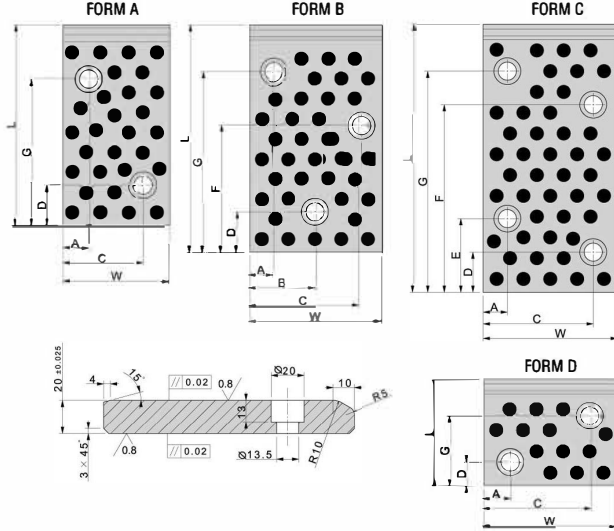
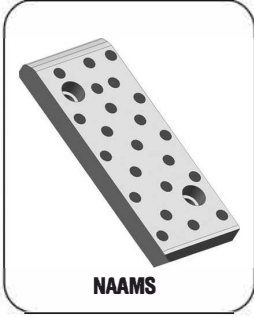

SİPARİŞ ÖRNEĞİ
SPB40 80 200
W L

Not: Toleranssız tüm ölçüler EN 22768-1(m) standardına göre tüm köşelere pah kırılacak.
Malzeme: SAE 430B HB>180 Kendinden yağlanmayı sağlayan özel grafit

SPB40

W▶	50▼			80▼			100▼					125▼					160▼									
L▶	100	150	200	100	150	200	250	315	50	80	100	150	200	250	315	80	100	150	200	250	315	100	150	200	250	315
A▶	25	25	25	20	20	20	20	20	22	22	22	22	22	22	22	25	25	25	25	25	25	30	30	30	30	30
B▶	-	-	-	-	-	-	-	40	-	-	-	-	50	50	50	-	-	-	62	62	-	-	-	80	-	
c▶	25	25	25	60	60	60	60	60	78	78	78	78	78	78	78	100	100	100	100	100	100	130	130	130	130	130
D▶	30	30	40	30	30	40	40	40	14	30	30	30	40	40	40	30	30	30	40	40	40	30	30	40	40	40
E▶	-	-	-	-	-	-	-	-	-	-	-	-	-	-	-	-	-	-	-	-	65	-	-	-	65	65
F▶	-	-	-	-	-	-	-	250	-	-	-	-	135	185	250	-	-	-	135	185	250	-	-	135	185	250
G▶	60	110	160	60	110	160	210	275	27	50	60	110	160	210	275	50	60	110	160	210	275	60	110	160	210	275
Hole▶	2	2	2	2	2	2	2	3	2	2	2	2	3	3	3	2	2	2	3	3	4	2	2	3	4	4
Form▶	A	A	A	A	A	A	B	D	D	A	A	B	B	B	B	D	A	A	B	B	C	A	A	B	C	C

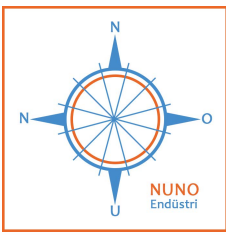

www.nunoendustri.com



SİPARİŞ ÖRNEĞİ
SPB44 160 180
L L1

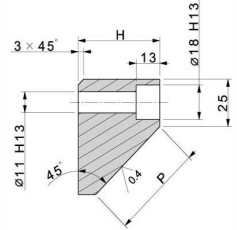
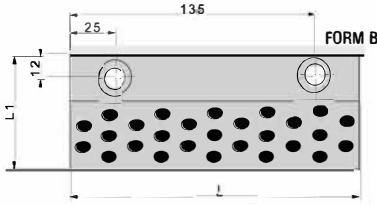
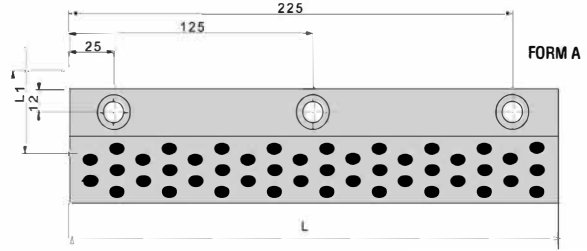

Not: Toleranssız tüm ölçüler EN 22768-1(m) standardına göre tüm köşelere pah kırılacak.

Malzeme: SAE 430B HB>180 Kendinden yağlanmayı sağlayan özel grafit

SPB44

L ▶	160 ▼		250 ▼	
L1 ▶	60	80	60	80
P ▶	50	80	50	80
H ▶	45	60	45	60
Form ▶	B	B	A	A

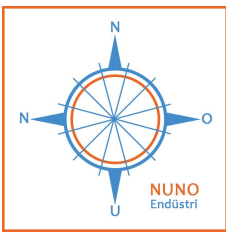

www.nunoendustri.com

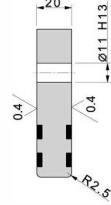
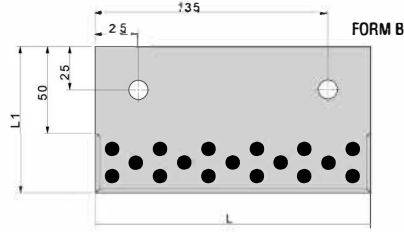
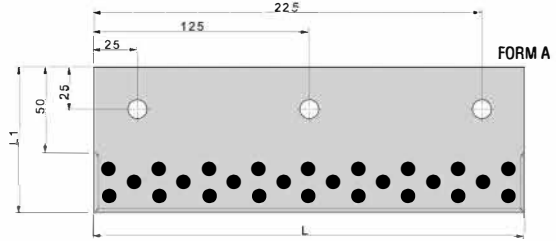
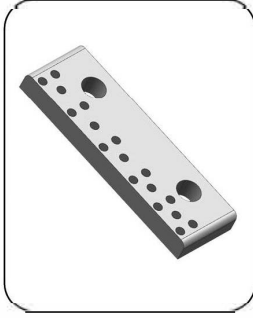

SİPARİŞ ÖRNEĞİ
SPB60 250
L

Not: Toleranssız tüm ölçüler EN 22768-1(m) standardına göre tüm köşelere pah kırılacak.

Malzeme: SAE 430B HB>180 Kendinden yağlanmayı sağlayan özel grafit

SPB60

L ▶	160▼	250▼
E ▶	20	20
L1 ▶	85	85
Form ▶	B	A

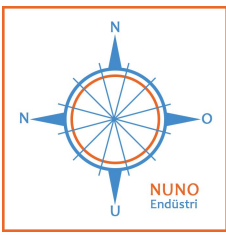

www.nunoendustri.com



FIAT ACC

SIPARIŞ ÖRNEĞİ
SPS01 75 150
A B

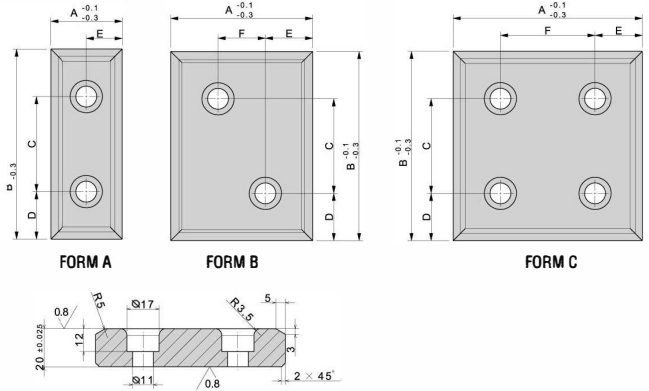

Not: Toleransız tüm ölçüler EN 22768-1(m) standardına göre tüm köşelere pah kırılacak.

Malzeme: CK45 58-60 HRC indüksiyon derinliği (1,4 - 2)mm

SPS01

A ▶	38 ▼		75 ▼		100 ▼	
B ▶	100	150	100	150	50	100
C ▶	50	100	50	100	50	100
D ▶	25	25	25	25	25	25
E ▶	19	19	25	37.5	25	25
F ▶	-	-	25	-	50	50
Form ▶	A	A	B	A	C	C

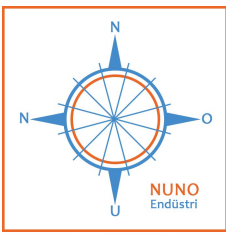

www.nunoendustri.com

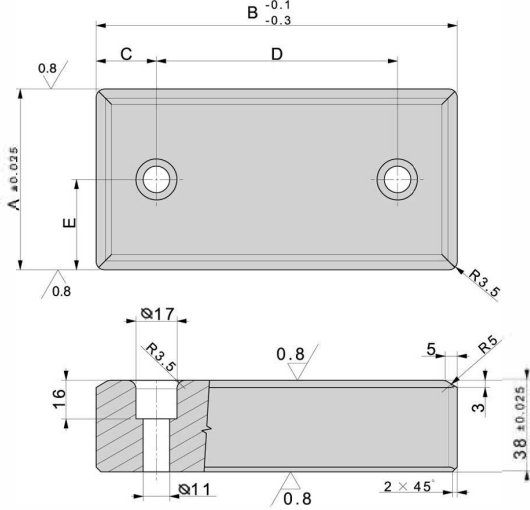
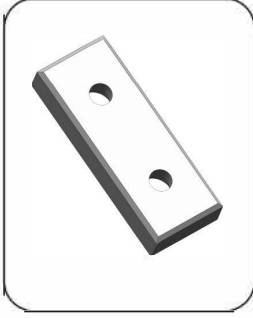

SIPARIŞ ÖRNEĞİ

SPS02 75 100
A B

Not: Toleranssız tüm ölçüler EN 22768-1(m) standardına göre tüm köşelere pah kırılacak.

Malzeme: CK45 58-60 HRC indüksiyon derinliği (1,4 - 2)mm

SPS02

A ▶	75 ▼	75 ▼
B ▶	100	150
C ▶	25	25
D ▶	50	100
E ▶	37.5	37.5

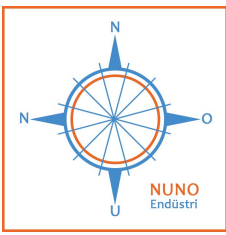

www.nunoendustri.com

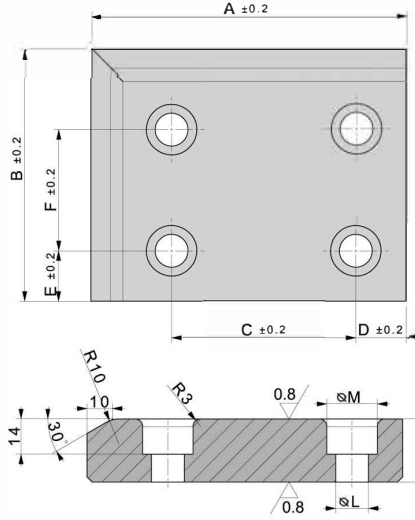
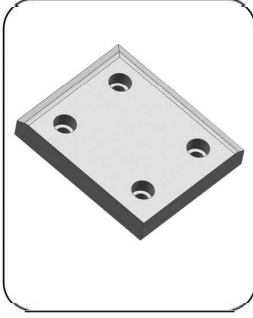

SIPARIŞ ÖRNEĞİ
SPS03 100 75
A B

Not: Toleranssız tüm ölçüler EN 22768-1(m) standardına göre tüm köşelere pah kırılacak.
Malzeme: CK45 58-60 HRC indüksiyon derinliği (1,4 - 2)mm

SPS03

A ▶	100▼	125▼	150▼
B ▶	75	100	125
C ▶	60	73	93
D ▶	15	20	25
E ▶	15	20	25
F ▶	35	48	68
G ▶	18	25	25
H ▶	12	14	14
L ▶	11	13	13
M ▶	18	20	20
Delik Sayısı ▶	2	4	4

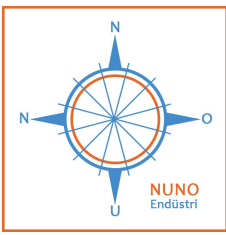

www.nunoendustri.com

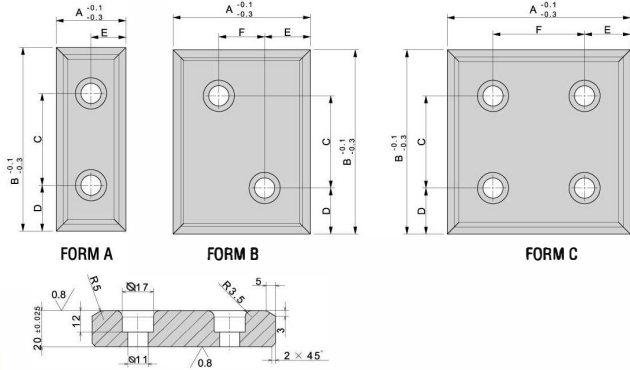

SİPARİŞ ÖRNEĞİ
SPS06 48 150
A B

Not: Toleranssız tüm ölçüler EN 22768-1(m) standardına göre tüm köşelere pah kırılacak.

Malzeme: CK45 58-60 HRC indüksiyon derinliği (1,4 - 2)mm

SPS06

	48▼	48▼	75▼	75▼
A▶				
B▶	100	150	100	150
C▶	25	25	25	25
D▶	50	100	50	100
E▶	24	24	24	24

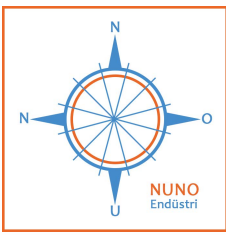

www.nunoendustri.com

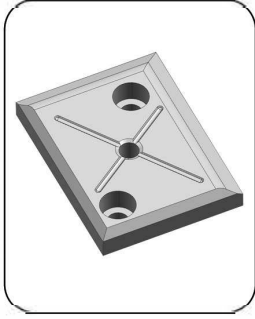

SIPARIŞ ÖRNEĞİ
SPS07 100
A

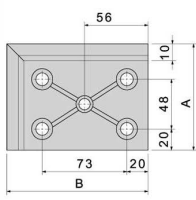

FORM A

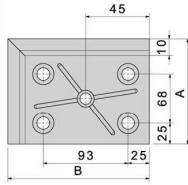

FORM C

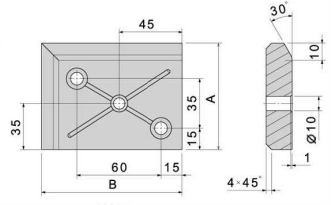
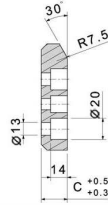

FORM B

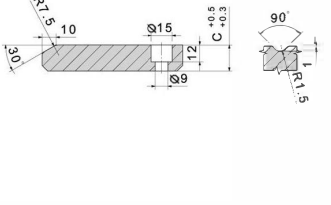
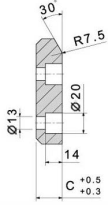

Not: Toleranssız tüm ölçüler EN 22768-1(m) standardına göre tüm köşelere pah kırılacak.

Malzeme: CK45 58-60 HRC indüksiyon derinliği (1,4 - 2)mm

SPS07

A ▶	75▼	100▼	125▼
B ▶	100	125	150
C ▶	18.5	25.5	25.5
Form ▶	A	B	C
Delik Sayısı ▶	2	4	4

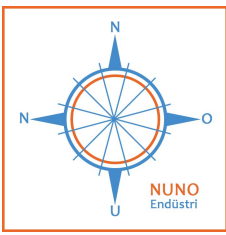

www.nunoendustri.com

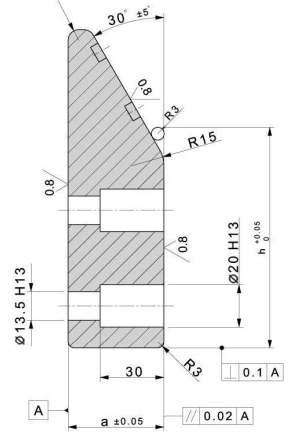
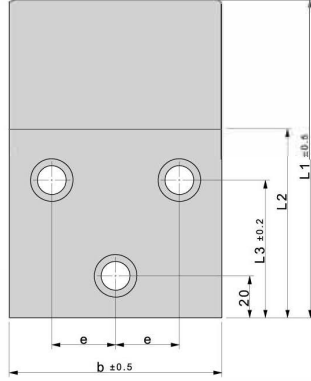
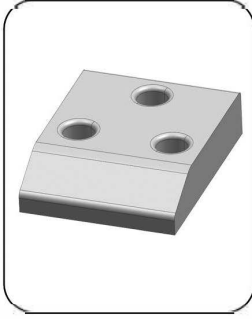

SİPARİŞ ÖRNEĞİ
SPS11 125 170
b L1

Not: Toleranssız tüm ölçüler EN 22768-1(m) standardına göre tüm köşelere pah kırılacak.
Malzeme: CK45 58-60 HRC indüksiyon derinliği (1,4 - 2)mm

SPS11

b ▶	100	100	100	125	125	125	100	100	100	125	125	125	100	100	100	125	125	125
L1 ▶	130	150	170	130	150	170	130	150	170	130	150	170	130	150	170	130	150	170
e ▶	30	30	30	42.5	42.5	42.5	30	30	30	42.5	42.5	42.5	30	30	30	42.5	42.5	42.5
h ▶	132.9	127.9	127.9	132.9	127.9	127.9	132.9	127.9	127.9	132.9	127.9	127.9	132.9	127.9	127.9	132.9	127.9	127.9
L2 ▶	95	90	90	95	90	90	95	90	90	95	90	90	95	90	90	95	90	90
L3 ▶	70	65	65	70	65	65	70	65	65	70	65	65	70	65	65	70	65	65
a ▶	30	45	60	30	45	60	30	45	60	30	45	60	30	45	60	30	45	60

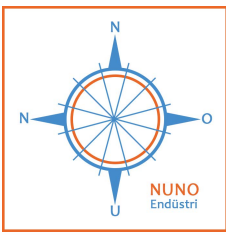

www.nunoendustri.com



VDI 3357

SIPARIŞ ÖRNEĞİ
SPS12 125 170 60
b a s

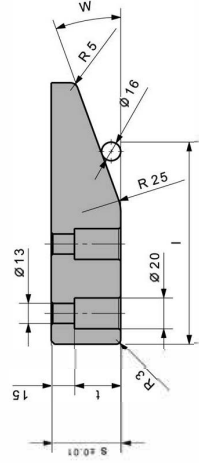
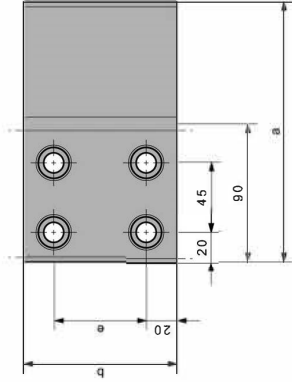

Not: Toleranssız tüm ölçüler EN 22768-1(m) standardına göre tüm köşelere pah kırılacak.
Malzeme: CK45 58-60 HRC indiksiyon derinliği (1,4 - 2)mm

SPS12

b ▶	100	125	150	100	100	125	125	150	150
a ▶	170	170	170	150	170	150	170	150	170
s ▶	45	45	45	45	60	45	60	45	60
e ▶	60	85	110	60	60	85	85	110	110
t ▶	30	30	30	30	45	30	45	30	45
w ▶	20°	20°	20°	30°	30°	30°	30°	30°	30°
l ▶	143,37	143,37	143,37	127,86	127,86	127,86	127,86	127,86	127,86

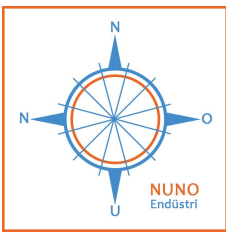

www.nunoendustri.com

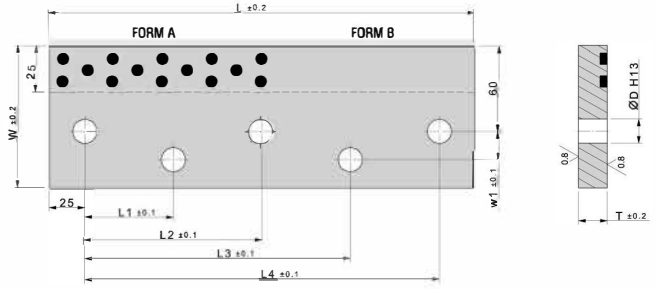
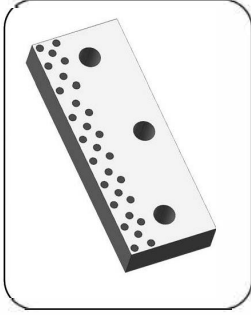

SIPARIŞ ÖRNEĞİ

SPS13 30 125 160
T W L

Not: Toleranssız tüm ölçüler EN 22768-1 (m) standardına göre tüm köşelere pah kırılacak.

Malzeme: CK45 58-60 HRC indüksiyon derinliği (1,4 - 2)mm

SPS13

T ▶	20 ▼				30 ▼				
W ▶	100	100	100	100	125	125	125	125	125
L ▶	160	200	250	300	160	250	300	350	400
L1 ▶	55	75	100	62.5	55.5	100	62.5	75	87.5
L2 ▶	110	150	200	125	110	200	125	150	175
L3 ▶	-	-	-	187.5	-	-	187.5	225	262.5
L4 ▶	-	-	-	250	-	-	250	300	350
w1 ▶	20	20	20	20	40	40	40	40	40
d ▶	14	14	14	14	18	18	18	18	18
H ▶	3	3	3	5	3	3	5	5	5
Form ▶	A	A	A	A	A	A	A	A	A

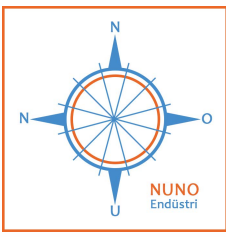

www.nunoendustri.com

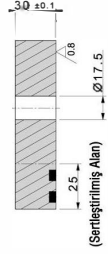
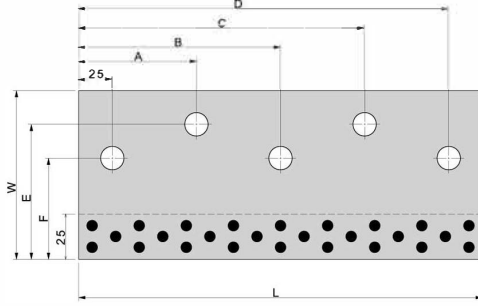
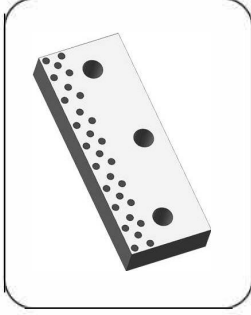

SİPARİŞ ÖRNEĞİ
SPS14 125 350
W L

Not: Toleranssız tüm ölçüler EN 22768-1(m) standardına göre tüm köşelere pah kırılacak.
Malzeme: CK45 58-60 HRC indüksiyon derinliği (1,4 - 2)mm

SPB14

W ▶	100▼						125▼					
L ▶	200	250	315	350	400	450	200	250	315	350	400	450
A ▶	100	60	90	100	115	125	100	90	90	100	115	125
B ▶	-	-	158	175	200	225	-	-	158	175	200	225
C ▶	-	160	225	250	285	325	-	160	225	250	285	325
D ▶	175	225	290	325	375	425	175	225	290	325	375	425
E ▶	80	80	80	80	80	80	105	105	105	105	105	105
F ▶	55	55	55	55	55	55	65	65	65	65	65	65
H ▶	3	4	5	5	5	5	3	4	5	5	5	5

W ▶	150▼						75▼					
L ▶	200	250	315	350	400	450	200	250	315	350	400	450
A ▶	100	60	90	100	115	125	100	90	90	100	115	125
B ▶	-	-	158	175	200	225	-	-	158	175	200	225
C ▶	-	160	225	250	285	325	-	160	225	250	285	325
D ▶	175	225	290	325	375	425	175	225	290	325	375	425
E ▶	130	130	130	130	130	130	55	55	55	55	55	55
F ▶	55	55	55	55	55	55	65	65	65	65	65	65
H ▶	3	4	5	5	5	5	3	4	5	5	5	5

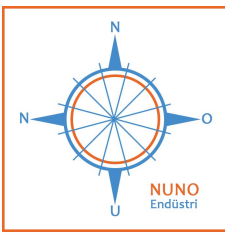

www.nunoendustri.com

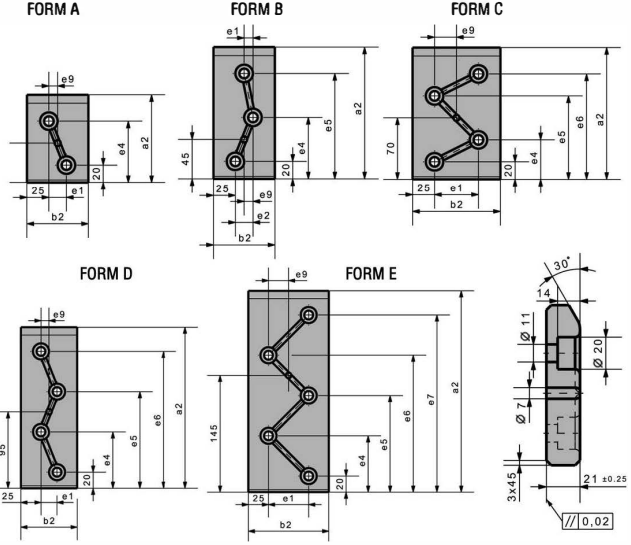

SIPARIŞ ÖRNEĞİ
SPS15 70 100 A
b2 a2 Form

Not: Toleransız tüm ölçüler EN 22768-1(m) standardına göre tüm köşelere pah kırılacak.
Malzeme: CK45 58-60 HRC indiksiyon derinliği (1,4 - 2)mm

SPS15

b2	a2	Form	e1	e2	e3	e4	e5	e6	e7	e8	e9	Delik Sayısı
70	100	A	20	-	-	70	-	-	-	-	10	2
70	150	B	10	20	-	70	120	-	-	-	10	3
70	200	D	20	-	-	70	120	170	-	-	10	4
100	150	C	50	-	-	45	95	120	-	-	25	4
100	200	D	50	-	-	70	120	170	-	-	25	4
100	250	E	50	-	-	70	120	170	220	-	25	5
150	200	D	100	-	-	70	120	170	-	-	50	4
150	250	E	100	-	-	70	120	170	220	-	50	5

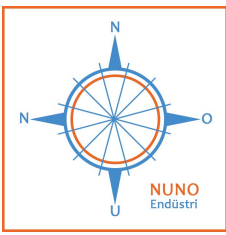

www.nunoendustri.com

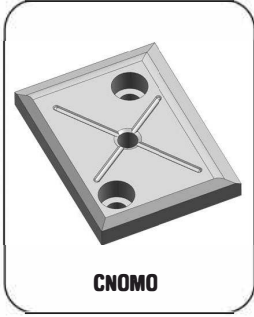

CNOMO

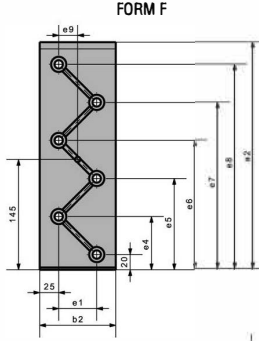

FORM F

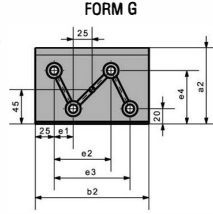

FORM G

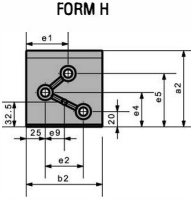

FORM H

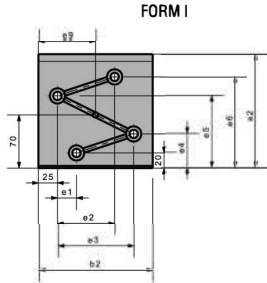

FORM I

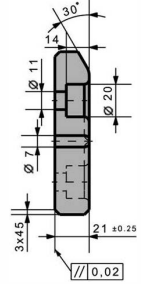

SİPARİŞ ÖRNEĞİ
SPS15 150 300 F
b2 a2 Form

Not: Toleransız tüm ölçüler EN 22768-1(m) standardına göre tüm köşelere pah kırılacak.

Malzeme: CK45 58-60 HRC indüksiyon derinliği (1,4 - 2)mm

SPS15

b2	a2	Form	e1	e2	e3	e4	e5	e6	e7	e8	e9	Delik Sayısı
100	100	I	30	50	-	45	70	-	-	-	25	3
100	300	F	50	-	-	70	120	170	220	270	25	6
150	100	G	25	75	100	70	-	-	-	-	50	4
150	150	H	25	75	100	45	95	120	-	-	50	4
150	300	F	100	-	-	70	120	170	220	270	50	6
200	100	G	50	100	150	70	-	-	-	-	75	4

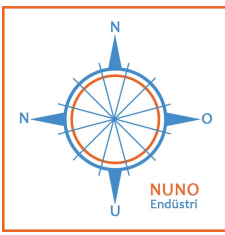

www.nunoendustri.com

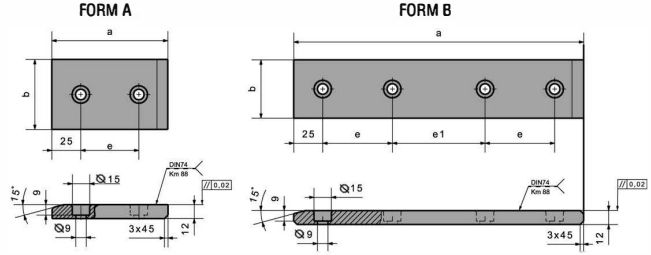

SIPARIŞ ÖRNEĞİ
SPS32 80 125 A
b a Form

Not: Toleranssız tüm ölçüler EN 22768-1(m) standardına göre tüm köşelere pah kırılacak.

Malzeme: CK45 58-60 HRC indüksiyon derinliği (1,4 - 2)mm

SPS32

b	a	e	Delik Sayısı
30	80	30	2
	100	50	2
	125	75	2
	160	110	2
40	200	150	2
	80	30	2
	100	50	2
	125	75	2
50	160	110	2
	200	150	2
	80	30	2
	100	50	2
60	125	75	2
	160	110	2
	200	150	2
	80	30	2
80	100	50	2
	125	75	2
	160	110	2
	200	150	2

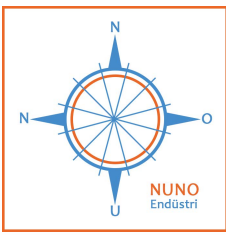

www.nunoendustri.com

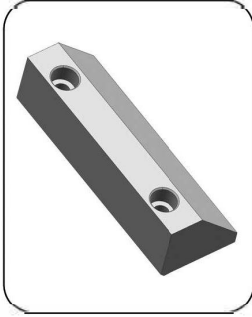

SIPARIŞ ÖRNEĞİ
SPS45 160 80
W L

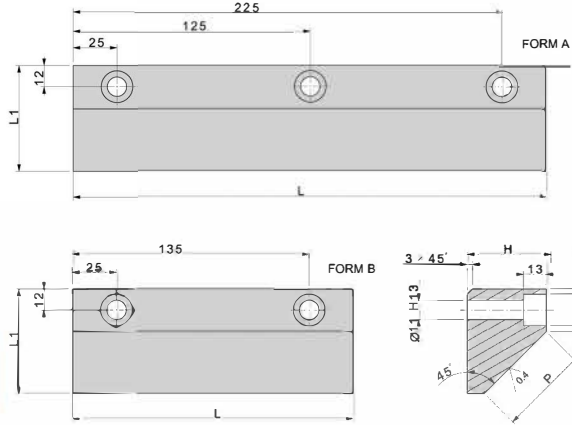

Not: Toleranssız tüm ölçüler EN 22768-1(m) standardına göre tüm köşelere pah kırılacak.

Malzeme: CK45 58-60 HRC indüksiyon derinliği (1,4 - 2)mm

SPS45

L ▶	160▼		250▼	
L1 ▶	60	80	60	80
P ▶	50	80	50	80
H ▶	45	60	45	60
Form ▶	B	B	A	A

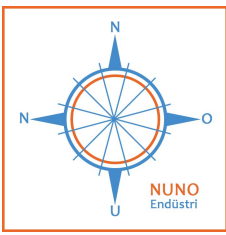

www.nunoendustri.com



SİPARİŞ ÖRNEĞİ
SPS88 50 160
W L

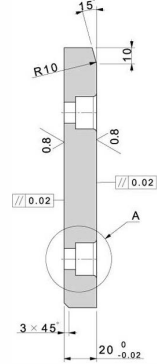
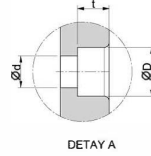
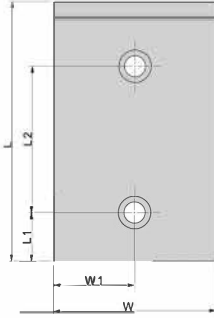

Not: Toleranssız tüm ölçüler EN 22768-1(m) standardına göre tüm köşelere pah kırılacak.

Malzeme: CK45 58-60 HRC indüksiyon derinliği (1,4 - 2)mm

SPS88

W ▶	$^{+0}_{-0.2}$	50	50	50	50	50	80	80	80	80	80	80	80	100	100	100	100	100	100
L ▶	$^{+0}_{-0.2}$	80	100	125	160	200	80	100	125	160	200	250	315	100	125	160	200	250	315
W1 ▶	$^{+0.1}$	25	25	25	25	25	40	40	40	40	40	40	40	50	50	50	50	50	50
L1 ▶	$^{+0.1}$	25	25	25	25	25	25	25	25	25	25	40	40	25	25	25	25	40	40
L2 ▶	$^{+0.1}$	30	50	75	110	150	30	50	75	110	150	170	235	50	75	110	150	170	235
D ▶	-	15	20	20	20	20	20	20	20	20	20	20	20	20	20	20	20	20	20
d ▶	-	9	13.5	13.5	13.5	13.5	13.5	13.5	13.5	13.5	13.5	13.5	13.5	13.5	13.5	13.5	13.5	13.5	13.5
t ▶	-	9	13	13	13	13	13	13	13	13	13	13	13	13	13	13	13	13	13

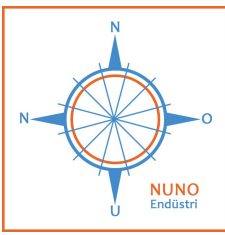

www.nunoendustri.com

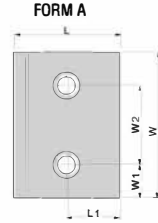
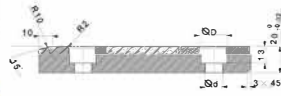
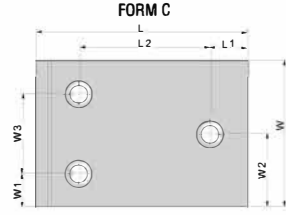
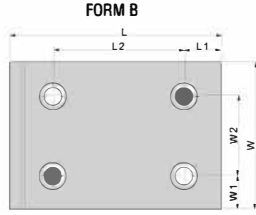

SİPARİŞ ÖRNEĞİ
SPS89 50 160
W L

Not: Toleranssız tüm ölçüler EN 22768-1(m) standardına göre tüm köşelere pah kırılacak.
Malzeme: CK45 58-60 HRC indüksiyon derinliği (1,4 - 2)mm

SPS89

W ▶	$\begin{matrix} +0 \\ -0,2 \end{matrix}$	80	100	100	125	125	125	125	125	125	125	125	160	160	160	160	160	160	160	160	
L ▶	$\begin{matrix} +0 \\ -0,2 \end{matrix}$	50	50	80	50	80	100	125	160	200	250	315	50	80	100	125	160	200	250	315	
W1 ▶	+0,1	25	25	25	25	25	25	25	25	25	25	25	25	25	25	25	25	25	25	25	
W2 ▶	+0,1	30	50	50	75	75	62,5	62,5	62,5	62,5	62,5	62,5	110	110	80	80	80	80	110	110	
W3 ▶	+0,1	-	-	-	-	-	75	75	75	75	75	75	-	-	110	110	110	110	-	-	
L1 ▶	+0,1	25	25	40	25	40	25	25	25	25	40	40	25	40	25	25	25	25	40	40	
L2 ▶	+0,1	-	-	-	-	-	50	75	110	150	170	235	-	-	50	75	110	150	170	235	
D ▶	15	20	20	20	20	20	20	20	20	20	20	20	20	20	20	20	20	20	20	20	
d ▶	9	13,5	13,5	13,5	13,5	13,5	13,5	13,5	13,5	13,5	13,5	13,5	13,5	13,5	13,5	13,5	13,5	13,5	13,5	13,5	
t ▶	9	13	13	13	13	13	13	13	13	13	13	13	13	13	13	13	13	13	13	13	
Form ▶		A	A	A	A	A	C	C	C	C	C	C	A	A	C	C	C	C	C	B	B